

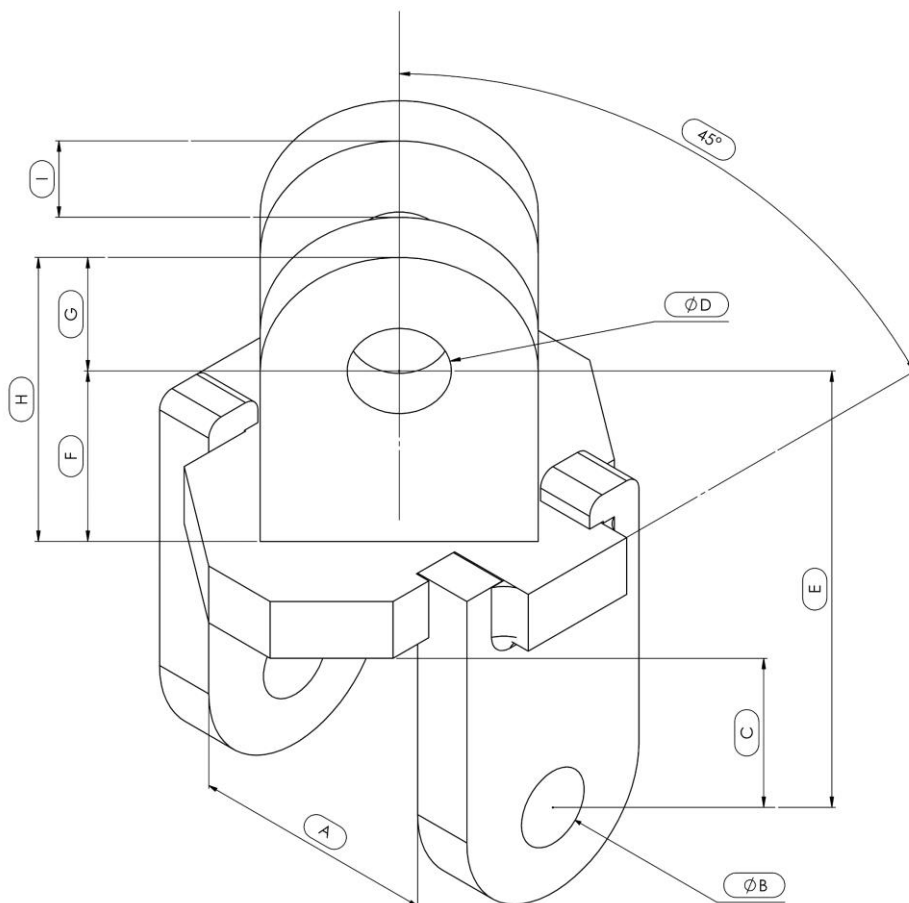

ATTACHE CROCHET SECMI : SU22C045045 CMU=4,5T



	DEMANDE	PALFINGER
A		87
B		25 OU 30
C		70,5
D		30
F		70,5
G		31
H		101,5
I		75



ATTACHE CROCHET SECMI :
SU22C045045 CMU=4,5T



- **Problème résolu**
 - ✓ Le crochet retombe côté intérieur du gabarit du camion.
 - ✓ Dimensions pour grue PALFINGER **tenues en stock.**
 - ➔ Choisir perçage d25 ou d30 en partie basse.